

Data Sheet

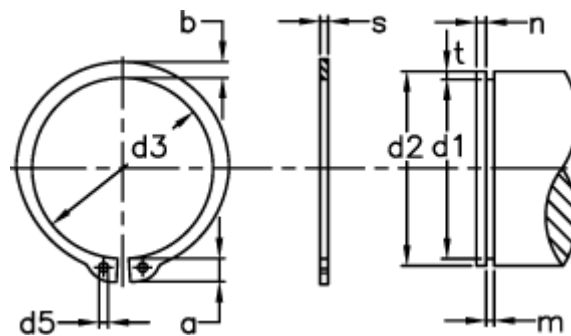

Article number: 0109072
 Description: Retaining ring AS 55x3.0
 Spring steel
 Note: Fitted with ZGA pliers

Measures



a max	= 8.5	Description	= AS 55	s	= 3.00
AN mm ²	= 252.0	FN kN	= 42.00	t	= 1.50
B	= 2.25	FRg kN	= 25.6	tol	= -0.30
b	= 5.4	FR kN	= 161.0	tol	= -0.08
d1	= 52.0	g	= 2.5	tol	= +0,46 -1,10
d2	= 55	m min	= 3.15	Tong	= ZGA-3
d3	= 50.8	n abl x 1000	= 9	Weight kg/1000	= 17.00
d5 min	= 2.5	Nominal drive	= 4.5		